

Megapixel Camera

THIS INSTALLATION SHOULD BE MADE BY A QUALIFIED SERVICE PERSON AND SHOULD CONFORM TO ALL LOCAL CODES.

VCC-HD4000P
VCC-HD4000
VCC-HDN4000PC

Please read this instruction manual carefully in order to ensure correct installation. In addition, be sure to read carefully the electronic manual contained in the supplied CD-ROM to ensure correct operation of the camera.

Contents

Information To User	1
Parts Names and Functions	3
What You Can Do	5
Network Settings Procedure	7
Connections	8
Viewing Live Video	13
Menu Screen List	14
Setting up the network information of the camera. . . .	15
Formatting the Recording Media	16
Setting a Password	17
Using the Supplied CD-ROM	18
Downloading and Playing back Recorded Video - Using "DLViewer_HDCDownloader" Software - . . .	19
Main specifications	29



Recording times and target sizes (Insert at the end of this manual)

MEMO: This manual covers three models. Any difference among the three models is indicated when necessary.

Installing Camera

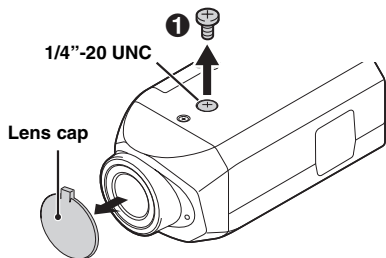

① Transportation screw and threaded holes for mounting (Top and Bottom)

When using a camera mount base (sold separately) etc., use an attachment screw shorter than 10 mm / 0.4 in.

Install the camera in a correct location so that the intended object can be monitored properly.

You should also adjust on the monitor side.







- If you want to use a commercially available platform for the camera, select an appropriate type, taking into consideration the gross weight of the camera and platform, and secure it on a firm place.
- Images may blur under extremely bright lighting; adjust the lighting angle to get clear images.

Information To User

For US and Canadian Users

Safety Guard

	CAUTION RISK OF ELECTRIC SHOCK DO NOT OPEN	
CAUTION: TO REDUCE THE RISK OF ELECTRIC SHOCK, DO NOT REMOVE COVER (OR BACK). NO USER-SERVICEABLE PARTS INSIDE. REFER SERVICING TO QUALIFIED SERVICE PERSONNEL.		

	The lightning flash with arrowhead symbol, within an equilateral triangle, is intended to alert the user to the presence of uninsulated "dangerous voltage" within the product's enclosure that may be of sufficient magnitude to constitute a risk of electric shock to persons.
	The exclamation point within an equilateral triangle is intended to alert the user to the presence of important operating and maintenance (servicing) instructions in the literature accompanying the product.

WARNING: To reduce a risk of fire or electric shock, do not expose this appliance to rain or moisture.

CAUTION: Changes or modifications not expressly approved by the manufacturer may void the user's authority to operate this equipment.

Precautions

■ In case of a problem

Do not use the unit if smoke or a strange odor comes from the unit, or if it seems not to function correctly. Turn off the power immediately and disconnect the power cord, and then consult your dealer or an Authorized Sanyo Service Center.

■ Do not open or modify

Do not open the cabinet, as it may be dangerous and cause damage to the unit. For repairs, consult your dealer or an Authorized Sanyo Service Center.

■ Be careful when handling the unit

To prevent damage, do not drop the unit or subject it to strong shock or vibration.

This equipment has been tested and found to comply with the limits for a Class B digital device, pursuant to Part 15 of the FCC Rules. These limits are designed to provide reasonable protection against harmful interference in a residential installation. This equipment generates, uses and can radiate radio frequency energy and, if not installed and used in accordance with the instructions, may cause harmful interference to radio communications. However, there is no guarantee that interference will not occur in a particular installation. If this equipment does cause harmful interference to radio or television reception, which can be determined by turning the equipment off and on, the user is encouraged to try to correct the interference by one or more of the following measures.

- Reorient or relocate the receiving antenna.
- Increase the separation between the equipment and receiver.
- Connect the equipment into an outlet on a circuit different from that to which the receiver is connected.
- Consult the dealer or an experienced radio/TV technician for help.

For the customers in Canada

This class B digital apparatus complies with Canadian ICES/NMB-003.

■ Do not put objects inside the unit

Make sure that no metal objects or flammable substance get inside the unit. If used with a foreign object inside, it could cause a fire, a short-circuit or damage. Be careful to protect the unit from rain, sea water, etc. If water or liquid gets inside the unit, turn off the power immediately and disconnect the power cord, and then consult your dealer or an Authorized Sanyo Service Center.

■ Do not install this unit close to magnetic fields

The magnetic fields may result in unstable operation.

For EU Users



Please note:

Your SANYO product is designed and manufactured with high quality materials and components which can be recycled and reused.

This symbol means that electrical and electronic equipment, at their end-of-life, should be disposed of separately from your household waste.

Please dispose of this equipment at your local community waste collection/recycling centre.

In the European Union there are separate collection systems for used electrical and electronic products.

Please help us to conserve the environment we live in!

This symbol mark and recycle system are applied only to EU countries and not applied to the countries in the other area of the world.

SANYO FISHER Sales (Europe) GmbH

Stahlgruberring 4, D-81829 München,
Germany

SANYO Electric Co., Ltd.

1-1, Sanyo-cho, Daito City, Osaka 574-8534,
Japan

For Russian Users



АЯ46

This product certified by official certification company which is authorized by Russian Federation.

ДЛЯ ПОЛЬЗОВАТЕЛЕЙ РОССИЯ

Данная продукция сертифицирована официальным органом по сертификации Российской Федерации.

■ Protect from humidity and dust

To prevent damage, do not install the unit where there is greasy smoke or steam, where the humidity may get too high, or where there is a lot of dust.

■ Protect from high temperatures

Do not install close to stoves, or other heat sources, such as spotlights, etc., or where it could be subject to direct sunlight, as this could cause deformation, discoloration or other damage.

Be careful when installing close to the ceiling, in a kitchen or boiler room, as the temperature may rise to high levels.

■ Cleaning

- Dirt can be removed from the cabinet by wiping it with a soft cloth. To remove stains, wipe with a soft cloth moistened with a soft detergent solution and wrung dry, then dry by wiping with a soft cloth.
- Do not use benzene, thinner or other chemical products on the cabinet, as this may cause deformation and paint peeling. Before using a chemical cloth, make sure to read all accompanying instructions. Make sure that no plastic or rubber material comes into contact with the cabinet for a long period of time, as this may cause damage or paint peeling.

Parts Names and Functions

■ Power/Error indicator

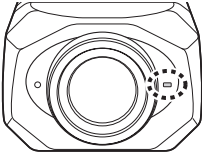

- Power ON : Lit (Startup time: 30 sec)
- Power OFF : Off
- Error (failure) : Blinks

MEMO:

To enable the power indicator, via the network, set [POWER LED (FRONT)] to "ON" on the OPTION SETTINGS screen.

■ Side Face

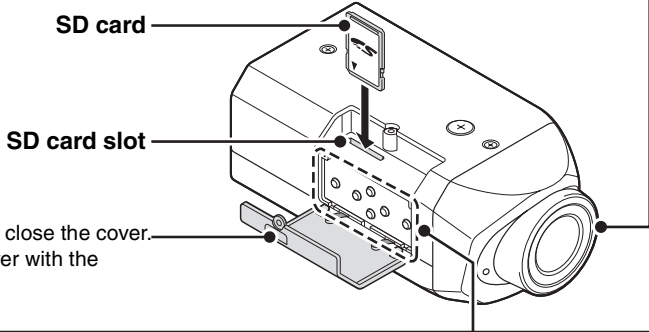

Side cover

After configuring settings, close the cover.
Be sure to secure the cover with the supplied screw.

Operation Buttons

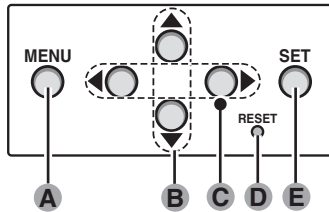

A MENU button

Displays the main menu.

B ▲▼ button

Moves the cursor upward/downward.

C ◀▶ button

Changes the setting value or moves the cursor to the right/left.

D RESET button

Press with a pen or other pointed object.

- Restarts the camera.
- Resets the settings.

To return all settings to defaults (factory settings), press the RESET button while holding down the MENU button.

E SET button

Selects the menu and confirms settings.

MEMO: The focus and zoom of live video can be adjusted. P13

■ Rear Face

👉 For connections, see pages 11 and 12.

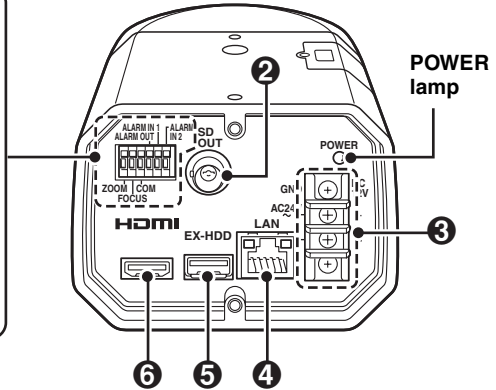
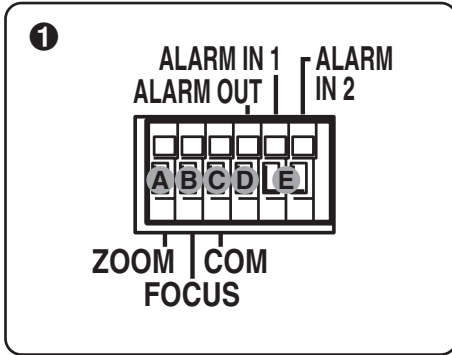

① Control terminals

When connecting the cable, press and hold down the protrusion of the terminal, insert the cable into the terminal, and then release the protrusion.

A ZOOM terminal

Used to zoom in/out by connecting an external switch.

- DC \pm (6-12V), +: WIDE, -: TELE

B FOCUS terminal

Used to perform the focus adjustment remotely by connecting an external switch.

- DC \pm (6-12V), +: FAR, -: NEAR

C COM terminal (Earth terminal)

D ALARM OUT terminal

Used to connect to an external buzzer or lamp.

When an alarm is detected, the device connected to the terminal notifies that an alarm is detected.

E ALARM IN 1/2 terminal

Used to connect an external alarm switch, infrared sensor, or other device.

It can also be used as a switching terminal for color and black/white video modes.

② SD OUT connector (BNC type)

Outputs SD (Standard Definition) video.

③ AC24V / DC12V terminals

Connect this terminal to the power supply.

- When the camera is turned on, the POWER lamp lights.

④ LAN connector (RJ-45)

Used to connect the camera to your network.

⑤ EX-HDD connector

Connects this connector to the external hard disk case (VA-HDC4000) dedicated to use with this camera.

For details, see the manual for the hard disk case.

⑥ HDMI connector

Outputs HD (High Definition) video. Connect this connector to an HD video device.

MEMO:

Select the SD OUT or HDMI terminal in on the TV OUT SETTING screen via the network.

What You Can Do

You can display the menu screen on your PC and configure settings.

Network Monitoring System

By connecting the camera to your PC via LAN cable, you can operate various functions required for monitoring from your PC's Web browser (Internet Explorer) via the network.

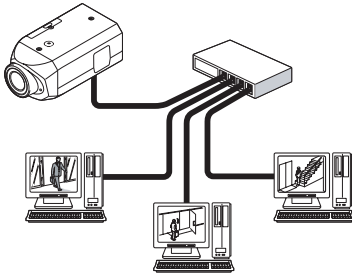

Security Measures

- Authentication by user ID and password is required when an access is attempted.
- Number of PC's that can access the camera can be restricted.
- SSL can be used to encrypt the content of communication.

Full High Definition

A high definition monitor can be connected to enable monitoring with HD video device.



Recording and Playing back Live Video

■ Recording

- Media (an SD card or external hard disk) can be installed on the camera to enable recording of live video when an alarm is detected. Still image and video are recorded.
- Recording can be programmed using timer and/or schedule functions.
- Optional software can be used to record (JPEG) live video on a PC.

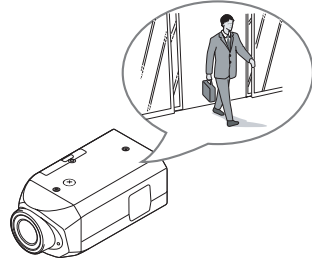

■ Downloading and Playing back

- The supplied software "DLViewer_HDCDownloader" can be used to download live video recorded through the camera to your PC for playback.
- Immediate playback is possible by installing the SD card or external hard disk directly to a PC.

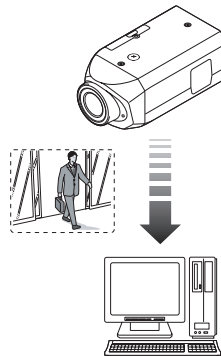

Alarm Functions

■ Detection

- The camera has a built-in motion sensor. The face detection function works in conjunction with the motion sensor to detect presence of human.

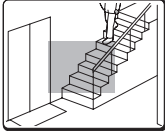

Not detected

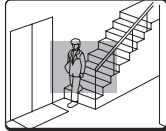

Detected

- Two types of alarm input, such as door open and close, can be set.



■ Notification

- When an alarm is detected, you can receive the image data as e-mail attachment.

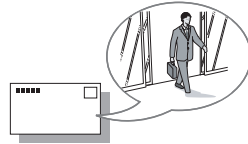

- A buzzer or lamp can be used to notify you of detection of alarm when you are in a distant place from the monitor.



- When the alarm condition is detected, the object on the screen is zoomed in.

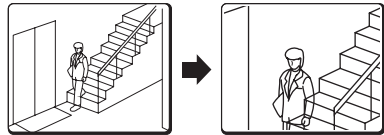

Privacy Masks

The privacy masks can be used to protect privacy by hiding certain part of the monitored image. (Maximum 5 masks)

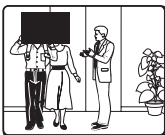

Clipping Function

You can clip a part of the live video for intensive monitoring and display it on the monitor.

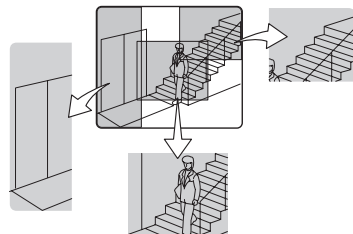

Network Settings Procedure

■ Checking the Operating Environment

- **PC** : IBM PC/AT and compatibles
- **OS** : Windows XP Professional/Windows Vista
- **CPU** : Core2Duo E6700 2.66 GHz or higher
- **Memory** : Windows XP : 1GB or more
Windows Vista : 2GB or more
- **Network interface** : 100Base-TX /1000Base-T (RJ-45 connector)
- **Graphics processor**: ATI RADEON HD2600 series or higher
nVIDIA GeForce 8600 series or higher
nVIDIA Quadro FX550 series or higher
- **Display card** : 1920 x 1200 pixels or higher
- **Web browser** : Internet Explorer Ver.6.0 or higher

■ Connecting the Camera to Your PC P8 - P12

To set the network information below, see "Quick Reference".

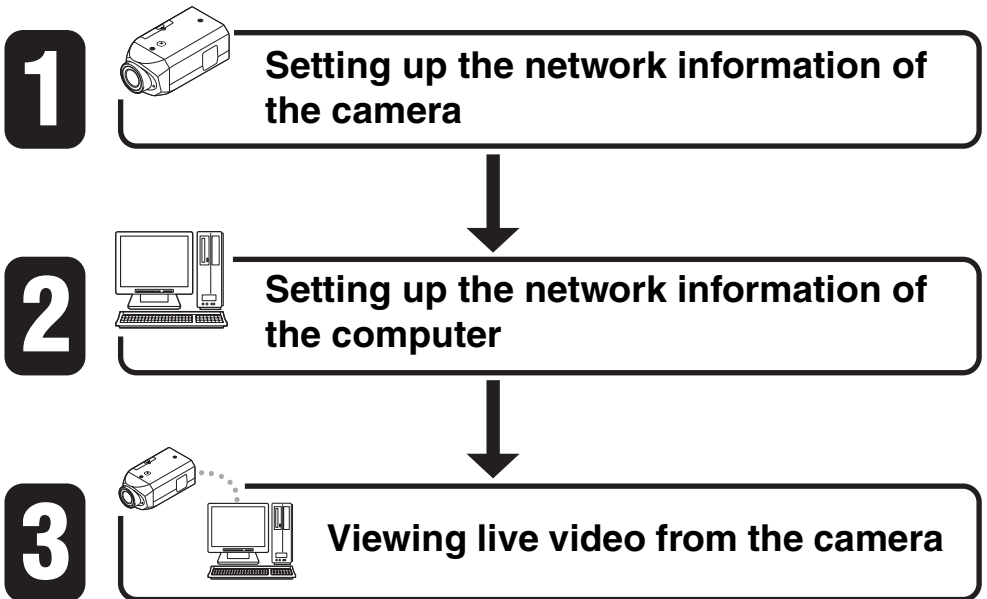

Connections

Connection when Using PoE (Power over Ethernet) Power Supply

This camera provides simultaneous delivery of video in the JPEG and H.264 formats and also bi-directional video between the camera and PC.



- Do not use the power supply of the camera.
- Do not supply power to the PoE hub or PoE power adapter until the camera installation is finished.

A Connect the camera to the LAN through a switching hub using shielded LAN cables.

You may extend the transmission distance by using multiple switching hubs with PoE support. For details on the extendable distance, please refer to the hub performance in the specifications, etc.

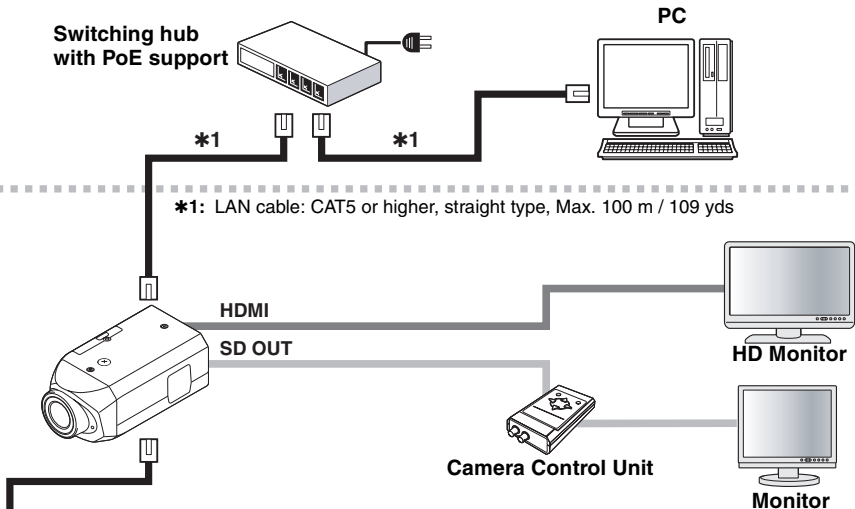

B Connect the camera to the LAN through a power adapter and a switching hub using shielded LAN cables.

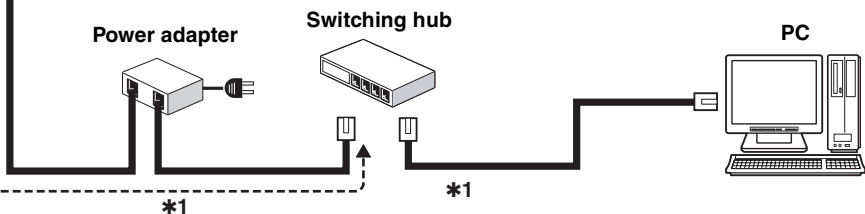

Connections

Connection when Not Using PoE (Power over Ethernet) Power Supply

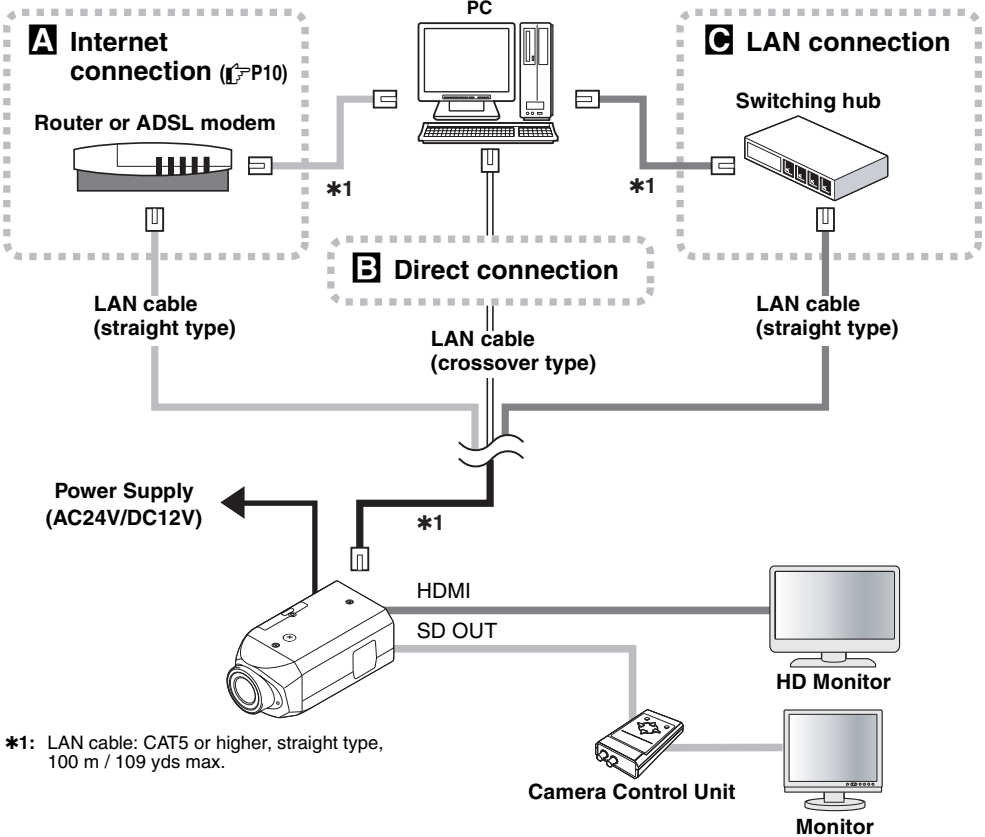

*1: LAN cable: CAT5 or higher, straight type, 100 m / 109 yds max.

About the “**A** Internet connection”

Port forwarding for the video port (HTTP/UDP) must be enabled on the broadband router.
For details on how to set port forwarding, please refer to your router's Instruction manual.

■ Port 1: JPEG/H.264 HTTP

Port number (default): 80 (TCP)
IP address (default): 192.168.0.2

Port number (default): 80 (TCP)
• Set to same value as on LAN

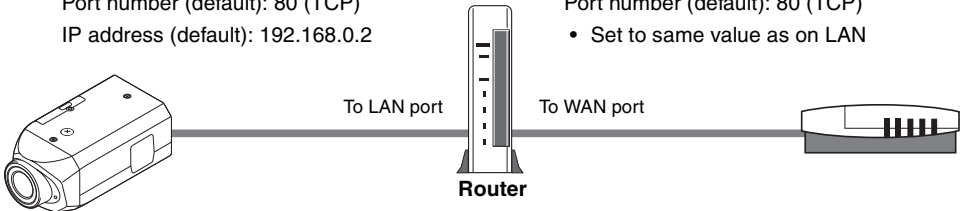

■ Port 2: H.264 UDP Unicast

Port number (default): 3939 (UDP)
IP address (default): 192.168.0.2

Port number (default): 3939 (UDP)
• Set to same value as on LAN

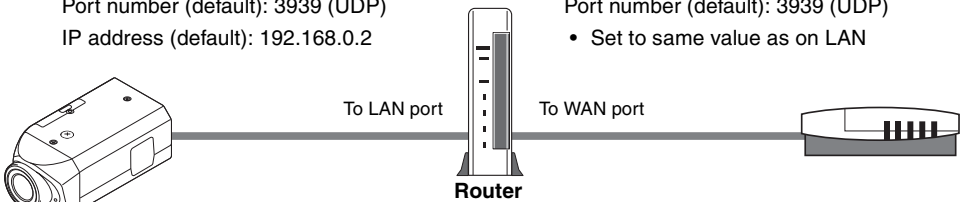

To view H.264 video over the Internet, set port forwarding for UDP to enable communication using UDP protocol. However, it may not be possible depending on your network environment. Consult your network administrator.

MEMO:

If you install multiple cameras, for second and later cameras, specify different numbers for ports 1 and 2 than those for the first camera via the network.

- Port 1: [NETWORK] → "PORT NUMBER"
- Port 2: [CODEC/STREAMING] → "UDP (Unicast) PORT"

Connections



Do not connect the power cord until all other connections have been completed.

Connection for Zoom/Focus

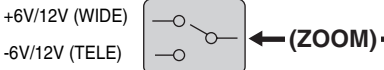
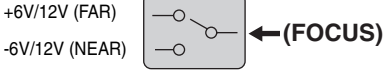

Alarm Signal Input

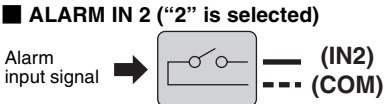
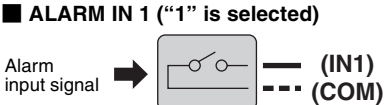

For switching between color and black/white video modes using an external switch, the alarm input terminals can also be used.

Alarm Signal Output

If a lamp is connected to this cable, it will light up when an alarm signal is received or when the built-in motion sensor detects movement.



Camera Control Unit
(Options:VAC-70)

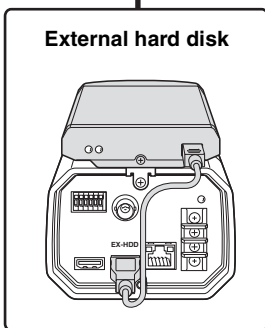
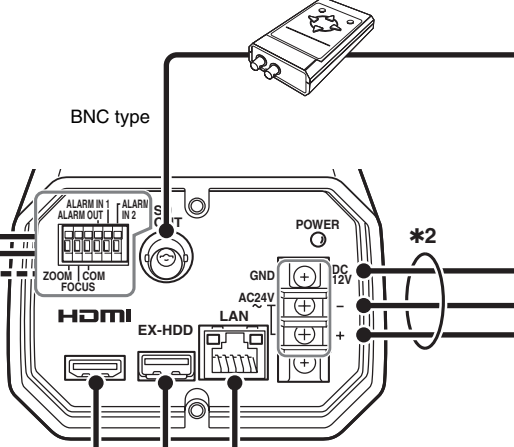

*1 Thicker than 24 AWG, 600 m / 656 yds. max.

Thicker than RG-6U (5C-2V): 500 m / 547 yds. max.

(Non-PoE power supply)

Power Supply Connection

To prevent a fire hazard use any UL listed wire rated VW-1.

GND
~ AC 24V
~

Check that +/- polarity is correct.

- DC 12V
+

*2 Thicker than 18 AWG

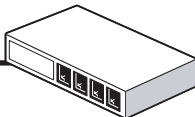

Switching hub

Monitor Connection



Using different cables from those specified here may attenuate the video and/or sync signals and interfere with correct transmission.

LAN Connection

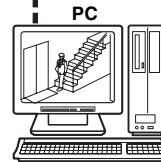
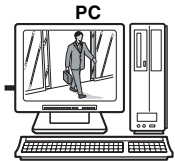
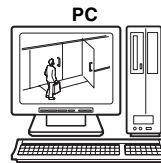

Shielded LAN cable

- ☞ "Connection when Using PoE (Power over Ethernet) Power Supply" (P8).
- ☞ "Connection when Not Using PoE (Power over Ethernet) Power Supply" (P9).

Viewing Live Video

When the camera is turned on, live video is displayed on the monitor.

The following information also appears. The display position can be selected from 12 positions on the TV OUT SETTINGS screen via the network.

Camera title

- Set on NETWORK SETTING screen via the network.

Recording/downloading status

- * Insert at the end of this manual



Zoom magnification

Alarm status

Zoom and Focus

The zoom and focus of live video can be adjusted with the buttons under the side cover.

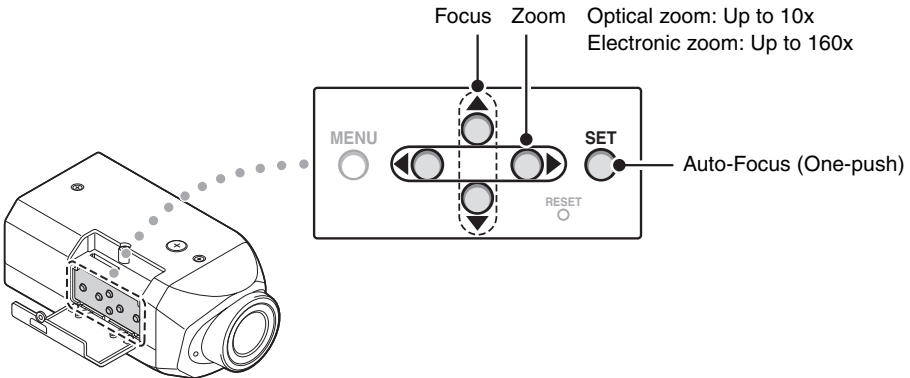

Menu Screen List

The settings below can be configured on the menu of the camera unit.

- Configure other settings on the Web-version menu screen.

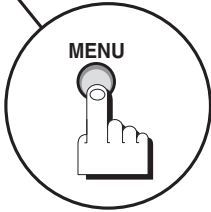
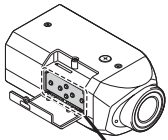

Main Menu

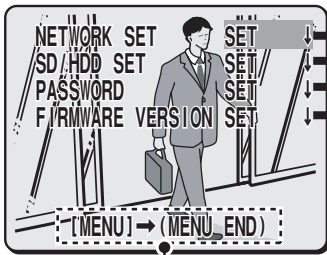

Press the MENU button to return to the previous screen.
"(MENU END)" indicates "exit the menu screen".

Network Settings P15

DHCP	OFF
IP ADDRESS	SET ↓
SUBNETMASK	SET ↓
GATEWAY	SET ↓
NETWORK SPEED	NO LIMIT
PORT	00080
DEFAULT	OFF
[MENU] → (MAIN MENU)	

Recording Media Settings P16

CAPACITY	FORMAT
SD : 2GB	NEW <input checked="" type="checkbox"/> ON
EX-HDD : 500GB	FMT OFF
FORMAT	SET ↓
[MENU] → (MAIN MENU)	

Password Settings P17

PASSWORD LOCK	OFF ↓
PASSWORD CHANGE	SET ↓
[MENU] → (MAIN MENU)	

Firmware Version

FIRMWARE VERSION	
MAIN VER:	0.00-00 (XXXXXX-XX)
SUB VER:	0.00-00 (XXXXXX-XX)
MAC ADDRESS	XX-XX-XX-XX-XX-XX
[MENU] → (MAIN MENU)	

Setting up the network information of the camera

<Default Settings>

- DHCP : OFF
- IP Address : 192.168.0.2
- Subnet Mask : 255.255.255.0
- Gateway : 192.168.0.1
- Network Speed (bandwidth limitation) : NO LIMIT
- Port Number : 80

If you wish to use the default settings, the settings below are not necessary.

- 1** Select [NETWORK SET] with the ▲▼ buttons and press the SET button.

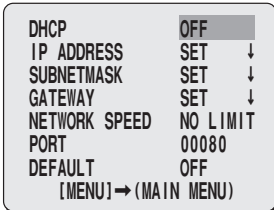

- 2** Select [DHCP] with the ▲▼ buttons and press the SET button.

- ♦ appears next to the selection "OFF" indicating that you can change the setting.



Select "OFF" or "ON" with the ▲▼ buttons and press the SET button.

OFF: Manual setting (go to step **3**)

ON: Automatic setting (go to step **5**)

- 3** Select [IP ADDRESS] with the ▲▼ buttons and press the SET button.

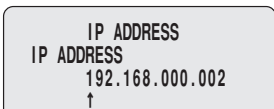

Select the input position with the ◀▶ buttons, select a value with the ▲▼ buttons, and press the SET button.

- 4** Use the same procedure as in step **2** to set up [SUBNETMASK] and [GATEWAY].

- 5** Select [NETWORK SPEED] with the ▲▼ buttons and press the SET button.

- ♦ appears next to the selection "NO LIMIT" indicating that you can change the setting.

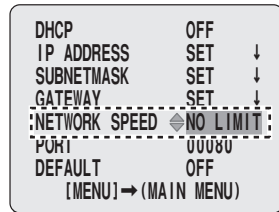

Select the network speed (bandwidth limitation) with the ▲▼ buttons and press the SET button.

NO LIMIT, 128, 256, 512 (Kbps), 1, 2, 3, 4, 5, 6 (Mbps)

- 6** Select [PORT] with the ▲▼ buttons and press the SET button.

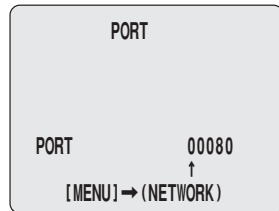

Select the input position with the ◀▶ buttons, select a value with the ▲▼ buttons, and press the SET button.

- 7** Press the MENU button to exit the settings.

Formatting the Recording Media

An SD card or external hard disk can be installed on the camera to record live video. Format the media before use.

● Installing an SD Card or External Hard Disk in the Camera

 Please refer to your media's Instruction manual.

<Media recording area setting>

When the media is formatted on the camera menu screen, the size of the normal recording area and that of the alarm recording area are automatically allocated in the ratio "80 : 20".

If you wish to specify a different size ratio, format the media in [RECORD] → [SD MEMORY CARD/EX HDD SETTINGS] via the network.

1 Select [SD/HDD SET] on the main menu with the ▲▼ buttons and press the SET button.

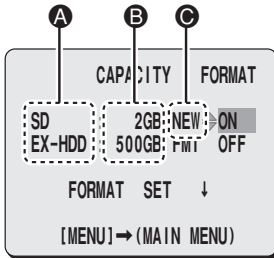

A Media type

SD: SD card

EX-HDD: External hard disk

B Media size

C Format status

FMT : Formatted

NEW : New (unformatted) media, or media that needs formatting because files in it could not be read.

---- : Camera could not recognize the media

2 Select the media to format with the ▲▼ buttons and press the SET button.

- ◆ appears next to the selection "OFF" indicating that initialization is possible.



3 Select "ON" with the ▲▼ buttons and press the SET button.



4 Select "FORMAT" with the ▲▼ buttons and press the SET button.

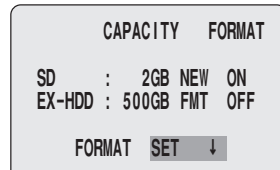

"CONTINUE?" appears. Select "YES" and press the SET button.

- Formatting begins.

Setting a Password

A password can be set to restrict access to the camera menu screen.

■ Setting the Password [PASSWORD LOCK]

- 1 Select [PASSWORD] in the main menu with the ▲▼ buttons and press the SET button.

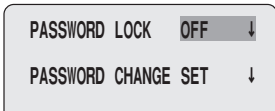

- 2 Select [PASSWORD LOCK] with the ▲▼ buttons and press the SET button.



Move the input position with the ◀▶ buttons and select values with the ▲▼ buttons. When finished, press the SET button.

- If you set a password for the first time, enter "1234".



- If you enter a wrong password three consecutive times, you must repeat the procedure from the beginning.

- 3 When "OK" appears, press the MENU button.

- You return to the PASSWORD screen and [PASSWORD LOCK] now shows "ON".

■ Changing the Password [PASSWORD CHANGE]

- 1 Select [PASSWORD] in the main menu with the ▲▼ buttons and press the SET button.

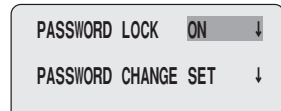

- 2 Select [PASSWORD CHANGE] with the ▲▼ buttons and press the SET button.

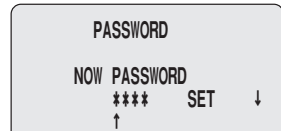

Enter the current password and press the SET button.

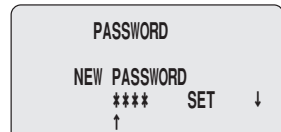

Enter a new password and press the SET button.

■ Releasing Password Lock [PASSWORD LOCK]

Follow steps 1 to 3 of "Setting the Password".

- You return to the PASSWORD screen and [PASSWORD LOCK] now shows "OFF".
- If you enter a wrong password three consecutive times, you must repeat the procedure from the beginning.

MEMO:

Change the password periodically to maintain security.

Using the Supplied CD-ROM

■ Software

The supplied CD-ROM contains the application software shown below.

These applications can be installed to expand the scope of use of the data recorded through the camera.

● DLViewer_HDCDownloader

This is software for downloading and playing back video data (JPEG/H.264) recorded through the camera.

 Page 19 of this manual.

● VA-SW3050Lite

This is monitoring software for use with Sanyo's cameras.

This software allows monitoring of live video from multiple cameras (up to 128 cameras).

 "VA-SW3050LITE" folder: Instruction Manual (PDF)

● H.264 Plug-in

This is software for playing back high-quality video.

This software is necessary for viewing H.264 live video on the screen via the network.

MEMO:

The separately available VA-SW3050 Server/Client can be purchased to record (JPEG) and play back live video on a PC.

■ Electronic manual

By using the electronic manual which is contained in the supplied CD-ROM, you can access extensive information from basic operation to advanced settings and functions, as well as troubleshooting.

● Requirements for viewing the electronic manual

Browser: Internet Explorer 6.0 or higher

- Make sure that JavaScript and Cookie are enabled.

1 Insert the CD-ROM into the CD drive of your computer and then double-click the “” icon.

2 Select the preferred language.

The electronic manual opens.

 You can also refer to “How to use this manual” to better understand the structure of the electronic manual and the description of individual screens.

● To open and view the instruction manual for the application software

You need Adobe Reader installed on your PC.

If it has not been installed on your PC, visit the Adobe website at <http://www.adobe.com> to download and install the free software program.

Downloading and Playing back Recorded Video - Using "DLViewer_HDCDownloader" Software -

This camera allows live video to be recorded.

The supplied software can be used to download live video recorded through the camera to your PC for playback.

■ HDC Downloader (Software for Downloading) P20

Video data recorded on an SD card or hard disk can be downloaded to a PC.

- You can select JPEG or H.264.
- You can search for video data to be downloaded by date and time or by alarm event.
- You can connect media (an SD card or hard disk) to your computer to copy video data.

■ DLViewer (Software for Playback) P21

This is used to play back downloaded video data.

- JPEG or H.264 can be played back.
- Images can be saved and printed.

Installing HDC Downloader and DLViewer

"HDC Downloader" and "DLViewer" can be installed at the same time.

1 Insert the supplied CD-ROM into your PC's CD-ROM drive.

2 Execute "Setup.exe" in "DLViewer_HDCDownloader" folder.

The installer will start. Follow the on-screen instructions to install the software.

Installation folder:

C:\Program Files\SANYO\HDC Utilites

When installation is finished, check the Internet options.

- Click [Tools] → [Internet Options] in Internet Explorer.
- ① [Security] tab → [Custom level]
 - Make sure that "Run ActiveX controls and plug-ins" is set to "Enable".
 - ② [Advanced] tab
 - Make sure that [Security] → [Check for server certificate revocation] is unchecked.

"H.264 Plug In"

If you attempt to play back H.264 video when the "H.264 Plug In" is not installed on your PC, a warning screen will appear.

Follow the on-screen instructions to install the plug-in.

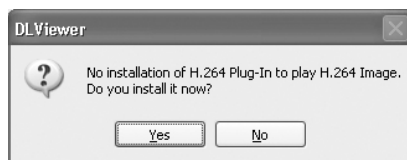

HDC Downloader Operation Flow

1



The HDC Downloader screen appears.

HDCDownloa...

A Download video data recorded on an SD card or external hard disk to your PC. P22

B Connect the SD card or external hard disk to your PC and copy the required image/video data from it. P26

2 Click "Download from Camera" and enter the network information.

2 Click "Copy from SD/HDD" and specify the drive and folder of the SD card or hard disk.

Download from Camera

IP address or URL: Port: SSL

Proxy Port:

Password:

Copy from SD/HDD

Image folder:

- Password: download

3 Select the type of image/video to be downloaded (JPEG or H.264).

3 Select the type of image/video to be downloaded (JPEG or H.264).

Download or Copy Image Type

JPEG H.264

Download or Copy Image Type

JPEG H.264

4 Select the search method.

4 Click the button.

Time/Date Search

Log	Start	End	Hour	Minute
1	7/25/2008 13:00	7/25/2008 13:12	13	00
2	7/25/2008 13:00	7/25/2008 13:12	13	00
3	7/25/2008 13:00	7/25/2008 13:12	13	00

Search folder: C:\Program Files\DAV\Foxit Software\Foxit Reader\Foxit Reader.exe

5 Specify the folder that contains the data you want to download and the folder to which the data will be downloaded.

6 Click the button.

Downloading and Playing back Recorded Video

DLViewer Operation Flow

1  The DLViewer screen appears.

2 Select the language.

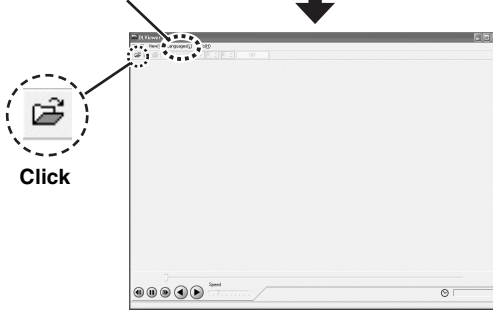

3 Select the type of image/video to play back (JPEG or H.264) and specify the folder.

[Example]  JPEG_TD_20080922_1030_001

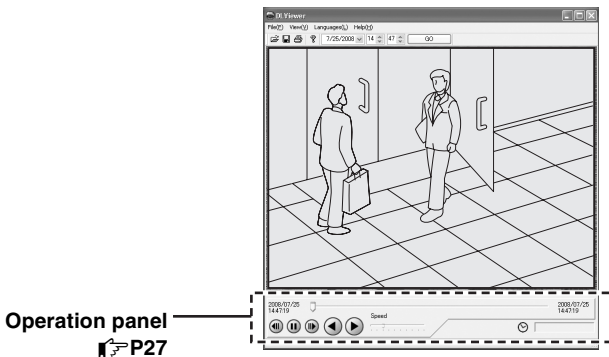

Downloading Recorded Video (HDC Downloader)

A Download video data recorded on an SD card or external hard disk to your PC.



HDCDownloa...

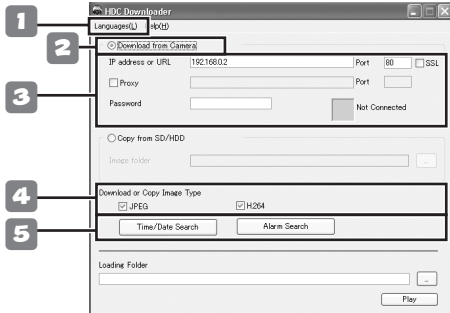

2 Select the display language.

3 Click the "Download from Camera" radio button.

4 Configure the network settings that are required for connection to the camera.

① IP address or URL

Enter the IP address (or URL) of the camera.

Default setting: 192.168.0.2

② Port

Enter the port number of the camera.

Default setting: 80

③ SSL

If you wish to transmit image/video using SSL encryption, select this check box.

- The port number will change to "443".

④ Proxy

If you will use a proxy server, select this checkbox and enter the server address (or URL) and port number.

⑤ Password

Enter the password of the download user set in the camera.

- If you are entering the password for the first time, enter "download".

⑥ Connection status display

The status of the connection with the camera is displayed.

5 Select the type of image/video to be downloaded (JPEG or H.264).

To download both JPEG and H.264, select both types.

6 Select the search method.

See the following for detailed explanations of the search methods.

• Time/Date Search:

Open the Time/Date Search screen.

 Carry out the procedure explained in "Download by Time/Date". (P23)

• Alarm Search:

Open the Alarm Search screen.

 Carry out the procedure explained in "Download by Alarm Event*1". (P23)

Downloading and Playing back Recorded Video

■ Download by Time/Date

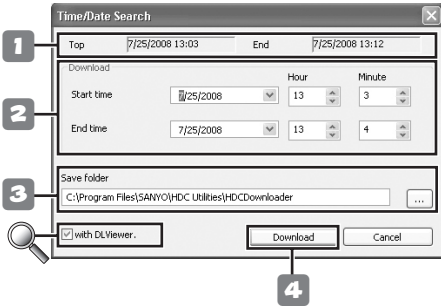

1 The start point [Top] and end point [End] are automatically displayed.

2 Set the [Start time] and [End time].

3 Click the [...] button and specify the folder in which the video data will be saved on your PC.

 If you will play back the video data on a PC that does not have DLViewer installed, select the [with DLViewer] checkbox.

The DLViewer playback software will be copied to the destination folder together with the necessary files.

 Go to step **4**. ( P24)

■ Download by Alarm Event*1

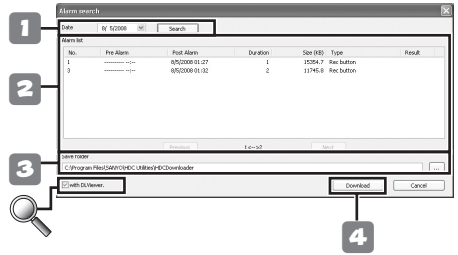

The [Alarm list] does not contain any alarm when you switch to the [Alarm Search] screen.

1 Specify the date of the alarm event that you are searching for in [Date] and click [Search].

Alarm events will appear in the [Alarm list].

2 Click the alarm event that you wish to download in [Alarm list].

Multiple alarm events can be selected.

3 Click the [...] button and specify the folder in which the video data will be saved on your PC.

 If you will play back the video data on a PC that does not have DLViewer installed, select the [with DLViewer] checkbox.

The DLViewer playback software will be copied to the destination folder together with the necessary files.

 Go to step **4**. ( P24)

***1** An alarm event is the data that was recorded when an alarm occurred.

4 Click [Download].

The size of the download data is calculated and a confirmation dialog box appears.

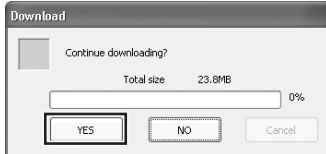

5 Click [Yes].

Downloading starts.

When the download is finished, "Finished." appears.

The folder below is automatically created in the destination folder.

(Explanation of the folder)

JPEG AL 20080922 1030 001

① ② ③ ④ ⑤

① Image format (JPEG/H264)

② Search method

- TD (Time/Date Search)
- AL (Alarm Search)

③ Year-month-day (example: September 22, 2008)

④ Hour-minute (example: 10:30)

⑤ File number

MEMO:

To cancel the download, click the [Cancel] button.

The download is cancelled; however, any data downloaded before the [Cancel] button is clicked is saved.

Click [Play].

"DLViewer" automatically starts and the video data is displayed.

MEMO:

Click [...] button and specify the folder that you wish to play back when you downloaded multiple video data.

[Example]  JPEG_TD_20080922_1030_001

 See "Playing back Downloaded Video Data (DLViewer)". (P27)

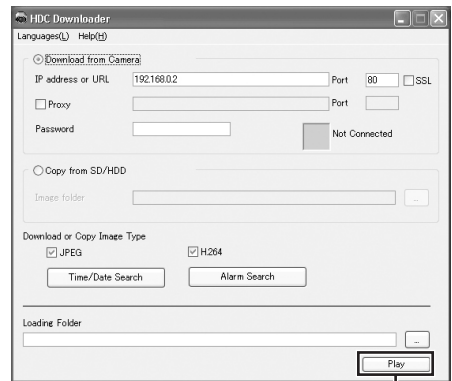

Downloading and Playing back Recorded Video

(Explanation of the alarm list)

The screenshot shows an 'Alarm list' window with a table of alarm events. Callouts A through G point to the columns: A (No.), B (Pre Alarm), C (Post Alarm), D (Duration), E (Size (KB)), F (Type), and G (Result). Callout H points to the navigation buttons at the bottom, which include 'Previous', '1 <-> 2', and 'Next'.

No.	Pre Alarm	Post Alarm	Duration	Size (KB)	Type	Result
1:..	8/5/2008 01:27	1	15354.7	Rec button	
3:..	8/5/2008 01:32	2	11745.8	Rec button	

A No.:

Alarm number

B Pre Alarm:

Start date and time of Pre Alarm recording.

C Post Alarm:

Start date and time of Post Alarm recording.

D Duration:

Approximate duration of recording (unit: minutes)

Maximum error: Approximately 2 minutes

E Size (KB):

Size of recorded data

F Type:

Alarm type

- **Alarm 1/2:**
Data detected on alarm input terminal 1/2.
- **Motion:**
Data detected by the motion sensor.
- **Network Failure:**
Data recorded that was triggered by communication error.
- **ALM1/2+M:**
Data simultaneously detected by alarm input terminal 1/2 and the motion sensor.
- **Rec button:**
Data recorded with REC button.

G Result:

- **Pass:** Download succeeded
- **Fail:** Download failed
- **No display:**
Download not yet executed

H Previous/Next button:

Click this button to show the hidden alarms when the number of alarm events exceeds 1000.

B Connect the SD card or external hard disk to your PC and copy the required image/video data from it.

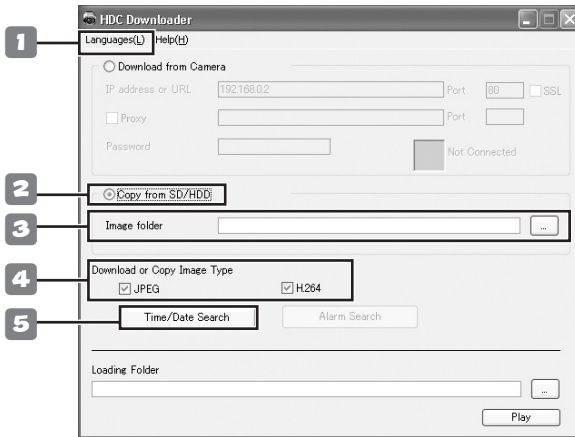

- 1** Select the display language.
- 2** Click the "Copy from SD/HDD" radio button.
- 3** Click the [...] button and specify the drive and folder of the SD card or hard disk.
- 4** Select the type of image/video to be downloaded (JPEG or H.264).

To download both JPEG and H.264, select both types.

5 Click [Time/Date Search].

[Alarm Search] cannot be used.

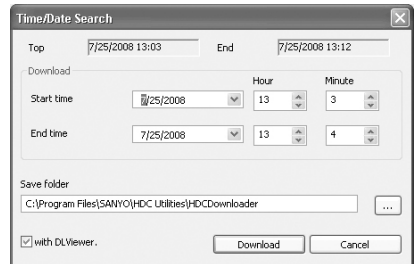

MEMO:

[Alarm Search] (specifying an image in the alarm list) cannot be used when copying image/video data from an SD card or hard disk.

Carry out the procedure explained in "Download by Time/Date". (P23)

Playing back Downloaded Video Data (DLViewer)

■ Using the operation panel

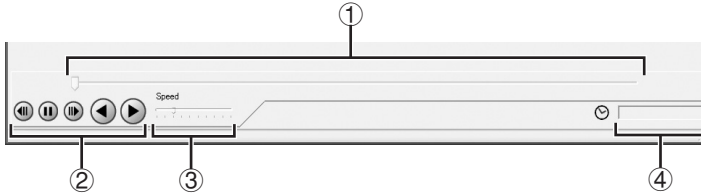

① Slide bar

Slide the knob to move the playback point.

MEMO:

The date and time of the starting point and ending point of the file appear at the ends of the slide bar.

② Playback buttons

: Moves back by frames when the video is paused.

: Pauses playback and shows a still image.

: Moves forward by frames when the video is paused.

: Plays backward.

: Plays forward.

MEMO:

To zoom in or out at a point, move the mouse pointer to that point and rotate the mouse wheel. You will zoom in or out in five steps.

Note:

Moving back by frames and playing backward are not possible with H.264 video data.

③ Speed bar (default setting: 3)

Slide the knob to change the playback speed.

- H.264: 5 steps
- JPEG: 10 steps

④ Date and time display

Shows the date and time of the video data being played back.

The year/month/day format can be changed.

See "Setting the Date Format". (P28)

⑤ Time/Date Search

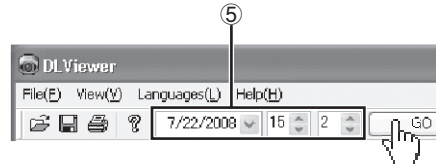

Specify the date and time of video data in the selected folder and click [GO].

The specified video data will be played back.

- If there is no video data with the specified date and time, the next video data will be played back.
If there is no next data, an error message will appear.

■ Saving and Printing Images

Saving an Image

- 1 Click  on the toolbar.



- 2 Specify the folder, filename, and file type, and click [Save].

Image data is saved as a still image.

File type:

Bitmap or JPEG can be selected.

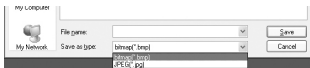

Printing an Image

- 1 Click  on the toolbar.



- 2 Check the print conditions and click [OK].

■ Displaying a title on the printed image

- ① Click [File] → [Title Input] on the menu bar.

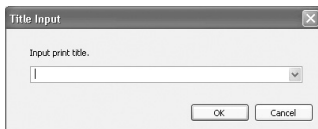

- Up to 10 set titles are stored. Stored titles can be selected from the pull-down menu.

- ② Enter a title in the [Title Input] screen and click [OK].

■ Date and Time Display Settings

Setting the Date Format

- 1 Select [View] → [Date Display Format] on the menu bar.

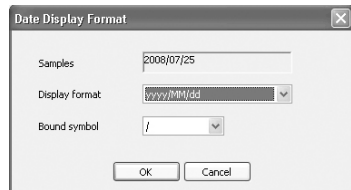
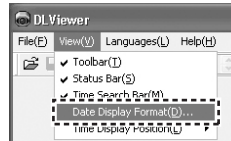

- 2 Select the display format and delimiter, and click [OK].

Setting the Time Display Position

Select [View] → [Time Display Position] on the menu bar and click the desired display position.

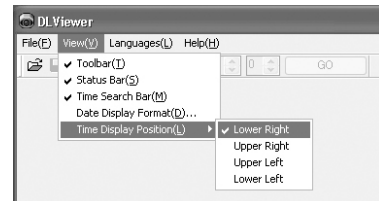

Main specifications

Television system		VCC-HD4000P/VCC-HDN4000PC: PAL color standards VCC-HD4000: NTSC color standards
Lens	Image pickup device	1/2.5" CMOS sensor
	Effective pixels	2,320 (H) × 1,728 (V), approx. 4.00 million pixels
	Recording pixels	2,288 (H) × 1,712 (V), approx. 3.92 million pixels
	Lens	Focal length: f = 6.3 - 63.0 mm (Optical 10×) F-number: F1.8 - 2.5 Electronic zoom: Max. ×16 (max. ×160 when combined with optical zoom)
Camera	Video size (H.264)	VCC-HD4000P/VCC-HDN4000PC: (16:9) HD 1920×1080p, HD 1280×720p, 960×540p, 640×360p, 320×180p (4:3) 1080×864p, 720×576p, 360×288p VCC-HD4000: (16:9) HD 1920×1080p, HD 1280×720p, 960×540p, 640×360p, 320×180p (4:3) 1080×720p, 720×480p, 360×240p
	Video size (JPEG)	(16:9) HD 1920×1080, HD 1280×720, 1024×576, 640×360 (4:3) 4M 2288×1712, 4M 1600×1200, 1280×960, 1024×768, 800×600, 640×480, 320×240
	Synchronization method	Internal synchronization
	Lowest image illumination	2.0 lx (at F1.8, color, high gain, VGA) 0.1 lx (at F1.8, black-and-white, high gain, VGA)
Recording and playback	Picture quality	BASIC, NORMAL, ENHANCED, FINE, SUPER FINE
	Recording rate	JPEG/H.264 selectable
	Recording mode	NORMAL/ALARM RECORDING: Timer recording REC BUTTON RECORDING: Emergency recording Backup recording in the event of a network recording failure: NORMAL (at failure detection), ALARM (timer recording)
I/O	Video output	HD output: HDMI connector SD output: BNC connector LAN: 10BASE-T/100BASE-TX/1000BASE-TX (RJ-45 connector) USB port: External hard disk case (2.5" HDD) supported SD card slot: 1 (SDHC, max. 32 GB) Alarm input: Control terminal 1/2 (NO (Normally Open) or NC (Normally Closed)), also used for day/night switching input Alarm output: Control terminal (NO/NC switching, 16V, 150mA, open collector) External lens control: Zoom, Focus, Common (Voltage control: ±6 to ±12V) Operation buttons: MENU, SET, RESET, cursor buttons (4)
Network	Image/video compression	H.264/JPEG
	Picture quality	BASIC, NORMAL, ENHANCED, FINE, SUPER FINE
	Bandwidth	NO LIMIT or selectable
	Interface	10BASE-T/100BASE-TX/1000BASE-TX (PoE)
	Protocol	TCP/IP, UDP, HTTP, HTTPS, SMTP, NTP, DHCP, FTP, UPnP, DDNS
	Simultaneous access	16
Others	Security	BASIC authentication (ID/password), SSL supported
	Operating ambient temperature/humidity	-10 to +50°C, 90% RH or less (no condensation)
	Power source	DC12V-15V AC24V ±10%, 50/60Hz
	Power consumption	12.3 W
	Weight	710 g

Appearance and specifications are subject to change without prior notice or obligations.

■ Service

The camera is a precision instrument. Handle it carefully and always follow the safety precautions. If the camera requires service, never try to repair it yourself or open the casing.

For servicing, maintenance, or repairs, consult your dealer or an Authorized Sanyo Service Center.

■ Notes on data storage

- It is recommended that important data be copied to a separate medium.
 - In the following situations, it is possible that recorded data may be lost (destroyed). Our company bears absolutely no responsibility for damages or profits loss due to the loss of data.
 - The medium (SD card or external hard disk) is not used correctly.
 - The medium is not installed on the device correctly.
 - The medium is subjected to electrical or mechanical shock.
 - The card is removed or the power is turned off while the card is being accessed.
 - The medium has reached the end of its service life.
-

■ Options

- Recording/Playback Software: VA-SW3050 Server/Client
- Camera Control Unit: VAC-70
- SANYO-specified external hard disk case: VA-HDC4000
For more information on the recommended hard disks, check the SANYO website:
- SD card (2 GB to 32 GB)
For more information on recommended SD cards, check the SANYO website:

www.sanyosecurity.com/

Recording times and target sizes

<CONTENTS>

■ Recording time by resolution

VCC-HD4000P/VCC-HDN4000PC

- ① Hard disk recording time P1
- ② SD memory card recording time P3

VCC-HD4000

- ① Hard disk recording time P5
- ② SD memory card recording time P7

■ Target size by resolution.....P9

- Recording time by resolution ■ Durée d'enregistrement par résolution
 ■ Aufnahmezeit nach Auflösung ■ Tiempo de grabación por resolución
 ■ 根据分辨率设置的录像时间

VCC-HD4000P/VCC-HDN4000PC

- ① Hard disk recording time ① Durée d'enregistrement du disque dur
 ① Festplatte Aufnahmezeit ① Tiempo de grabación de disco duro
 ① 硬盘录像时间

80GB	Picture quality		SUPER FINE	FINE	ENHANCED	NORMAL	BASIC
	Resolution	Recording rate (ips)					
H.264 (16:9)	1920 × 1080p	25	14.4	16.5	19.2	23.0	28.8
		12.5	15.9	18.4	21.9	27.1	38.3
	1280 × 720p	25	17.4	20.6	25.0	31.9	45.9
		12.5	19.5	23.0	28.1	35.9	52.2
	960 × 540p	25	23.0	28.1	35.9	49.9	88.0
		12.5	28.8	35.1	45.0	62.7	103.8
	640 × 360p	25	63.7	77.4	97.7	132.4	205.5
		12.5	71.6	86.0	108.7	145.8	225.6
	320 × 180p	25	225.6	267.5	319.3	396.1	546.1
		12.5	250.1	294.8	348.3	441.6	603.2
H.264 (4:3)	1080 × 864p	25	17.4	20.6	25.0	31.9	45.9
		12.5	19.5	23.0	28.1	35.9	52.2
	720 × 576p	25	32.9	40.0	51.2	71.6	116.4
		12.5	35.9	43.8	56.0	78.4	129.4
	360 × 288p	25	114.1	137.1	174.5	234.8	370.6
		12.5	126.6	153.6	191.9	261.4	410.2
JPEG (16:9)	1920 × 1080	5	14.0	16.1	19.3	24.0	32.0
		2.5	27.9	32.3	38.6	48.1	64.1
		1	69.8	80.7	96.5	120.1	160.2
		0.5	139.5	161.4	193.1	240.3	320.3
		0.2	348.8	403.5	482.7	600.7	800.8
		0.1	697.6	806.9	965.4	1201.4	1601.7
	1280 × 720	8	18.0	20.2	23.1	30.0	45.0
		5	28.8	32.3	37.0	48.0	72.0
		2.5	57.7	64.5	73.9	96.1	144.1
		1	144.2	161.4	184.8	240.2	360.2
		0.5	288.3	322.7	369.6	480.4	720.4
		0.2	720.8	806.8	924.0	1201.0	1801.1
	1024 × 576	0.1	1441.5	1613.6	1848.0	2402.1	3602.2
		12.5	19.7	22.2	28.3	36.8	55.7
		8	30.7	34.6	44.3	57.5	87.1
		5	49.1	55.4	70.9	92.0	139.3
		2.5	98.3	110.9	141.7	183.9	278.7
		1	245.7	277.1	354.3	459.8	696.7
	640 × 360	0.5	491.3	554.3	708.6	919.5	1393.4
		0.2	1228.3	1385.7	1771.6	2298.8	3483.4
		0.1	2456.6	2771.4	3543.2	4597.5	6966.9
		25	15.4	17.3	22.2	28.8	43.2
		12.5	30.9	34.6	44.3	57.6	86.3
		8	48.2	54.0	69.2	90.0	134.9
	640 × 360	5	77.2	86.4	110.8	144.0	215.8
		2.5	154.4	172.9	221.6	287.9	431.6
		1	385.9	432.2	553.9	719.9	1079.0
		0.5	771.9	864.4	1107.9	1439.7	2157.9
		0.2	1929.6	2161.0	2769.7	3599.4	5394.9
		0.1	3859.3	4321.9	5539.5	7198.7	10789.7

- This table shows the total values for the normal area and the alarm area.
- Ce tableau indique les valeurs totales pour la zone normale et la zone d'alarme.
- In dieser Tabelle werden die Gesamtwerte des normalen Aufnahmebereichs und der Alarmaufnahmebereichs aufgeführt.
- Este cuadro muestra los valores totales para el área normal y el área de alarma.
- 本表显示正常区域和警报区域的总值。

80GB	Picture quality		SUPER FINE	FINE	ENHANCED	NORMAL	BASIC
	Resolution	Recording rate (ips)					
JPEG (4:3)	2288 × 1712	2.5	16.0	19.0	23.4	30.4	43.2
		1	40.1	47.5	58.5	75.9	108.1
		0.5	80.1	95.1	116.9	151.8	216.2
		0.2	200.3	237.7	292.3	379.4	540.6
		0.1	400.5	475.3	584.5	758.8	1081.2
	1600 × 1200	5	16.0	18.8	22.8	28.8	39.3
		2.5	32.0	37.6	45.5	57.7	78.6
		1	80.1	94.0	113.8	144.2	196.6
		0.5	160.2	188.0	227.6	288.3	393.1
		0.2	400.5	470.1	569.1	720.8	982.8
		0.1	801.0	940.2	1138.1	1441.5	1965.5
	1280 × 960	8	13.5	15.2	17.3	22.5	33.8
		5	21.6	24.3	27.7	36.0	54.0
		2.5	43.2	48.6	55.4	72.1	108.1
		1	108.1	121.5	138.6	180.2	270.2
		0.5	216.2	243.0	277.2	360.4	540.4
		0.2	540.6	607.4	693.1	900.9	1351.1
	1024 × 768	0.1	1081.2	1214.8	1386.1	1801.8	2702.2
		12.5	12.1	13.5	17.3	22.5	33.9
		8	18.9	21.1	27.0	35.1	53.0
		5	30.2	33.8	43.2	56.1	84.7
		2.5	60.5	67.6	86.5	112.3	169.5
		1	151.2	168.9	216.2	280.7	423.7
		0.5	302.4	337.8	432.4	561.5	847.5
	800 × 600	0.2	756.0	844.6	1081.0	1403.7	2118.6
		0.1	1512.1	1689.2	2162.0	2807.4	4237.3
		12.5	19.7	22.2	28.3	36.8	55.7
		8	30.7	34.6	44.3	57.5	87.1
		5	49.1	55.4	70.9	92.0	139.3
		2.5	98.3	110.9	141.7	183.9	278.7
		1	245.7	277.1	354.3	459.8	696.7
		0.5	491.3	554.3	708.6	919.5	1393.4
	640 × 480	0.2	1228.3	1385.7	1771.6	2298.8	3483.4
		0.1	2456.6	2771.4	3543.2	4597.5	6966.9
		25	15.4	17.3	22.2	28.8	43.2
		12.5	30.9	34.6	44.3	57.6	86.3
		8	48.2	54.0	69.2	90.0	134.9
		5	77.2	86.4	110.8	144.0	215.8
		2.5	154.4	172.9	221.6	287.9	431.6
		1	385.9	432.2	553.9	719.9	1079.0
		0.5	771.9	864.4	1107.9	1439.7	2157.9
	320 × 240	0.2	1929.6	2161.0	2769.7	3599.4	5394.9
		0.1	3859.3	4321.9	5539.5	7198.7	10789.7
		25	24.7	33.2	41.1	57.5	78.3
		12.5	49.4	66.4	82.2	115.0	156.6
		8	77.1	103.8	128.5	179.7	244.8
		5	123.4	166.1	205.5	287.5	391.6
		2.5	246.9	332.2	411.1	575.0	783.2
1		617.2	830.4	1027.7	1437.5	1958.0	
0.5		1234.3	1660.9	2055.4	2875.0	3916.0	
320 × 240	0.2	3085.9	4152.1	5138.5	7187.5	9790.1	
	0.1	6171.7	8304.3	10277.1	14375.1	19580.2	

- Recording time varies depending on the recording rate and recording image quality. The recording times indicated in the table are reference values when an external hard disk is installed on this camera that may vary depending on the video image quality and other conditions.
- La durée d'enregistrement varie en fonction du taux d'enregistrement et de la qualité de l'image enregistrée. Les durées d'enregistrement indiquées dans le tableau sont des valeurs de référence quand un disque dur externe est installé sur cette caméra ; elles peuvent varier en fonction de la qualité de l'image vidéo et d'autres conditions.
- Die Aufnahmezeit variiert je nach Aufnahmegeschwindigkeit und Qualität des aufgenommenen Bildes. Die in der Tabelle angeführten Aufnahmezeiten dienen als Referenzwerte, wenn für diese Kamera eine externe Festplatte installiert wurde, und können je nach Videobildqualität und anderen Bedingungen variieren.
- El tiempo de grabación varía en función de la tasa de grabación y de la calidad de las imágenes de grabación. Los tiempos de grabación que se indican en la anterior son valores de referencia cuando un disco duro externo está instalado en esta cámara los mismos que podrían variar en función de la calidad de imágenes y otras condiciones.
- 录像时间会根据录像速率和录像图像质量而变化。表中表示的录像时间为该摄像头安装外置硬盘之后的参考值，它们可能会根据视频图像质量及其它条件而变化。

VCC-HD4000P

- ② SD memory card recording time
- ② Durée d'enregistrement de la carte mémoire SD
- ② SD-Speicherkarte Aufnahmezeit
- ② Tiempo de grabación de la tarjeta de memoria SD
- ② SD 记忆卡录像时间

2GB	Picture quality		SUPER FINE	FINE	ENHANCED	NORMAL	BASIC
	Resolution	Recording rate (ips)					
H.264 (16:9)	1920 × 1080p	25	0.3	0.4	0.4	0.5	0.6
		12.5	0.3	0.4	0.5	0.6	0.8
	1280 × 720p	25	0.4	0.4	0.5	0.7	1.0
		12.5	0.4	0.5	0.6	0.8	1.1
	960 × 540p	25	0.5	0.6	0.8	1.1	1.9
		12.5	0.6	0.8	1.0	1.4	2.3
	640 × 360p	25	1.4	1.7	2.1	2.9	4.5
		12.5	1.6	1.9	2.4	3.2	4.9
	320 × 180p	25	4.9	5.8	7.0	8.6	11.9
		12.5	5.4	6.4	7.6	9.6	13.1
H.264 (4:3)	1080 × 864p	25	0.4	0.4	0.5	0.7	1.0
		12.5	0.4	0.5	0.6	0.8	1.1
	720 × 576p	25	0.7	0.9	1.1	1.6	2.5
		12.5	0.8	1.0	1.2	1.7	2.8
	360 × 288p	25	2.5	3.0	3.8	5.1	8.1
		12.5	2.8	3.3	4.2	5.7	8.9
JPEG (16:9)	1920 × 1080	5	0.3	0.4	0.4	0.5	0.7
		2.5	0.6	0.7	0.8	1.0	1.4
		1	1.5	1.8	2.1	2.6	3.5
		0.5	3.0	3.5	4.2	5.2	7.0
		0.2	7.6	8.8	10.5	13.1	17.4
		0.1	15.2	17.6	21.0	26.2	34.9
	1280 × 720	8	0.4	0.4	0.5	0.7	1.0
		5	0.6	0.7	0.8	1.0	1.6
		2.5	1.3	1.4	1.6	2.1	3.1
		1	3.1	3.5	4.0	5.2	7.8
		0.5	6.3	7.0	8.1	10.5	15.7
		0.2	15.7	17.6	20.1	26.2	39.2
	1024 × 576	0.1	31.4	35.1	40.3	52.3	78.5
		12.5	0.4	0.5	0.6	0.8	1.2
		8	0.7	0.8	1.0	1.3	1.9
		5	1.1	1.2	1.5	2.0	3.0
		2.5	2.1	2.4	3.1	4.0	6.1
		1	5.4	6.0	7.7	10.0	15.2
	640 × 360	0.5	10.7	12.1	15.4	20.0	30.4
		0.2	26.8	30.2	38.6	50.1	75.9
		0.1	53.5	60.4	77.2	100.1	151.8
		25	0.3	0.4	0.5	0.6	0.9
		12.5	0.7	0.8	1.0	1.3	1.9
		8	1.1	1.2	1.5	2.0	2.9
	640 × 360	5	1.7	1.9	2.4	3.1	4.7
		2.5	3.4	3.8	4.8	6.3	9.4
		1	8.4	9.4	12.1	15.7	23.5
		0.5	16.8	18.8	24.1	31.4	47.0
		0.2	42.0	47.1	60.3	78.4	117.5
		0.1	84.1	94.1	120.7	156.8	235.0

- This table shows the total values for the normal area and the alarm area.
- Ce tableau indique les valeurs totales pour la zone normale et la zone d'alarme.
- In dieser Tabelle werden die Gesamtwerte des normalen Aufnahmebereichs und der Alarmaufnahmebereichs aufgeführt.
- Este cuadro muestra los valores totales para el área normal y el área de alarma.
- 本表显示正常区域和警报区域的总值。

2GB	Picture quality		SUPER FINE	FINE	ENHANCED	NORMAL	BASIC
	Resolution	Recording rate (ips)					
JPEG (4:3)	2288 × 1712	2.5	0.3	0.4	0.5	0.7	0.9
		1	0.9	1.0	1.3	1.7	2.4
		0.5	1.7	2.1	2.5	3.3	4.7
		0.2	4.4	5.2	6.4	8.3	11.8
		0.1	8.7	10.4	12.7	16.5	23.6
	1600 × 1200	5	0.3	0.4	0.5	0.6	0.9
		2.5	0.7	0.8	1.0	1.3	1.7
		1	1.7	2.0	2.5	3.1	4.3
		0.5	3.5	4.1	5.0	6.3	8.6
		0.2	8.7	10.2	12.4	15.7	21.4
		0.1	17.4	20.5	24.8	31.4	42.8
	1280 × 960	8	0.3	0.3	0.4	0.5	0.7
		5	0.5	0.5	0.6	0.8	1.2
		2.5	0.9	1.1	1.2	1.6	2.4
		1	2.4	2.6	3.0	3.9	5.9
		0.5	4.7	5.3	6.0	7.8	11.8
		0.2	11.8	13.2	15.1	19.6	29.4
	1024 × 768	0.1	23.6	26.5	30.2	39.2	58.9
		12.5	0.3	0.3	0.4	0.5	0.7
		8	0.4	0.5	0.6	0.8	1.2
		5	0.7	0.7	0.9	1.2	1.8
		2.5	1.3	1.5	1.9	2.4	3.7
		1	3.3	3.7	4.7	6.1	9.2
	800 × 600	0.5	6.6	7.4	9.4	12.2	18.5
		0.2	16.5	18.4	23.5	30.6	46.1
		0.1	32.9	36.8	47.1	61.1	92.3
		12.5	0.4	0.5	0.6	0.8	1.2
		8	0.7	0.8	1.0	1.3	1.9
		5	1.1	1.2	1.5	2.0	3.0
	640 × 480	2.5	2.1	2.4	3.1	4.0	6.1
		1	5.4	6.0	7.7	10.0	15.2
		0.5	10.7	12.1	15.4	20.0	30.4
		0.2	26.8	30.2	38.6	50.1	75.9
		0.1	53.5	60.4	77.2	100.1	151.8
		25	0.3	0.4	0.5	0.6	0.9
	320 × 240	12.5	0.7	0.8	1.0	1.3	1.9
		8	1.1	1.2	1.5	2.0	2.9
		5	1.7	1.9	2.4	3.1	4.7
		2.5	3.4	3.8	4.8	6.3	9.4
		1	8.4	9.4	12.1	15.7	23.5
		0.5	16.8	18.8	24.1	31.4	47.0
	320 × 240	0.2	42.0	47.1	60.3	78.4	117.5
		0.1	84.1	94.1	120.7	156.8	235.0
		25	0.5	0.7	0.9	1.3	1.7
		12.5	1.1	1.4	1.8	2.5	3.4
		8	1.7	2.3	2.8	3.9	5.3
		5	2.7	3.6	4.5	6.3	8.5
	320 × 240	2.5	5.4	7.2	9.0	12.5	17.1
1		13.4	18.1	22.4	31.3	42.6	
0.5		26.9	36.2	44.8	62.6	85.3	
0.2		67.2	90.4	111.9	156.6	213.2	
0.1		134.4	180.9	223.9	313.1	426.5	

- Recording time varies depending on the recording rate and recording image quality. The recording times indicated in the table are reference values when an SD memory card is installed in this camera that may vary depending on the video image quality and other conditions.
- La durée d'enregistrement varie en fonction du taux d'enregistrement et de la qualité de l'image enregistrée. Les durées d'enregistrement indiquées dans le tableau sont des valeurs de référence quand une carte mémoire SD est installée sur cette caméra ; elles peuvent varier en fonction de la qualité de l'image vidéo et d'autres conditions.
- Die Aufnahmezeit variiert je nach Aufnahmegeschwindigkeit und Qualität des aufgenommenen Bildes. Die in der Tabelle angeführten Aufnahmezeiten dienen als Referenzwerte, wenn für diese Kamera eine SD-Speicherkarte installiert wurde, und können je nach Videobildqualität und anderen Bedingungen variieren.
- El tiempo de grabación varía en función de la tasa de grabación y de la calidad de las imágenes de grabación. Los tiempos de grabación que se indican en la tabla son valores de referencia cuando una tarjeta de memoria SD está instalada en esta cámara los mismos que podrían variar en función de la calidad de imágenes y otras condiciones.
- 录像时间会根据录像速率和录像图像质量而变化。表中表示的录像时间为该摄像头安装 SD 记忆卡之后的参考值，它们可能会根据视频图像质量及其它条件而变化。

VCC-HD4000

- ① Hard disk recording time ① Durée d'enregistrement du disque dur
 ① Festplatte Aufnahmezeit ① Tiempo de grabación de disco duro
 ① 硬盘录像时间

80GB	Picture quality		SUPER FINE	FINE	ENHANCED	NORMAL	BASIC
	Resolution	Recording rate (ips)					
H.264 (16:9)	1920 × 1080p	30	14.4	16.5	19.2	23.0	28.8
		15	15.9	18.4	21.9	27.1	38.3
	1280 × 720p	30	17.4	20.6	25.0	31.9	45.9
		15	19.5	23.0	28.1	35.9	52.2
	960 × 540p	30	23.0	28.1	35.9	49.9	88.0
		15	28.8	35.1	45.0	62.7	103.8
	640 × 360p	30	63.7	77.4	97.7	132.4	205.5
		15	71.6	86.0	108.7	145.8	225.6
	320 × 180p	30	225.6	267.5	319.3	396.1	546.1
		15	250.1	294.8	348.3	441.6	603.2
H.264 (4:3)	1080 × 720p	30	17.4	20.6	25.0	31.9	45.9
		15	19.5	23.0	28.1	35.9	52.2
	720 × 480p	30	32.9	40.0	51.2	71.6	116.4
		15	35.9	43.8	56.0	78.4	129.4
	360 × 240p	30	114.1	137.1	174.5	234.8	370.6
		15	126.6	153.6	191.9	261.4	410.2
JPEG (16:9)	1920 × 1080	5	14.0	16.1	19.3	24.0	32.0
		3	23.3	26.9	32.2	40.0	53.4
		1	69.8	80.7	96.5	120.1	160.2
		0.5	139.5	161.4	193.1	240.3	320.3
		0.2	348.8	403.5	482.7	600.7	800.8
		0.1	697.6	806.9	965.4	1201.4	1601.7
	1280 × 720	10	14.4	16.1	18.5	24.0	36.0
		5	28.8	32.3	37.0	48.0	72.0
		3	48.1	53.8	61.6	80.1	120.1
		1	144.2	161.4	184.8	240.2	360.2
		0.5	288.3	322.7	369.6	480.4	720.4
		0.2	720.8	806.8	924.0	1201.0	1801.1
	1024 × 576	0.1	1441.5	1613.6	1848.0	2402.1	3602.2
		15	16.4	18.5	23.6	30.7	46.4
		10	24.6	27.7	35.4	46.0	69.7
		5	49.1	55.4	70.9	92.0	139.3
		3	81.9	92.4	118.1	153.3	232.2
		1	245.7	277.1	354.3	459.8	696.7
	640 × 360	0.5	491.3	554.3	708.6	919.5	1393.4
		0.2	1228.3	1385.7	1771.6	2298.8	3483.4
		0.1	2456.6	2771.4	3543.2	4597.5	6966.9
		30	12.9	14.4	18.5	24.0	36.0
		15	25.7	28.8	36.9	48.0	71.9
		10	38.6	43.2	55.4	72.0	107.9
		5	77.2	86.4	110.8	144.0	215.8
		3	128.6	144.1	184.6	240.0	359.7
		1	385.9	432.2	553.9	719.9	1079.0
		0.5	771.9	864.4	1107.9	1439.7	2157.9
		0.2	1929.6	2161.0	2769.7	3599.4	5394.9
		0.1	3859.3	4321.9	5539.5	7198.7	10789.7

- This table shows the total values for the normal area and the alarm area.
- Ce tableau indique les valeurs totales pour la zone normale et la zone d'alarme.
- In dieser Tabelle werden die Gesamtwerte des normalen Aufnahmebereichs und der Alarmaufnahmebereichs aufgeführt.
- Este cuadro muestra los valores totales para el área normal y el área de alarma.
- 本表显示正常区域和警报区域的总值。

80GB	Picture quality		SUPER FINE	FINE	ENHANCED	NORMAL	BASIC
	Resolution	Recording rate (ips)					
JPEG (4:3)	2288 × 1712	3	13.4	15.8	19.5	25.3	36.0
		1	40.1	47.5	58.5	75.9	108.1
		0.5	80.1	95.1	116.9	151.8	216.2
		0.2	200.3	237.7	292.3	379.4	540.6
		0.1	400.5	475.3	584.5	758.8	1081.2
	1600 × 1200	5	16.0	18.8	22.8	28.8	39.3
		3	26.7	31.3	37.9	48.1	65.5
		1	80.1	94.0	113.8	144.2	196.6
		0.5	160.2	188.0	227.6	288.3	393.1
		0.2	400.5	470.1	569.1	720.8	982.8
		0.1	801.0	940.2	1138.1	1441.5	1965.5
	1280 × 960	10	10.8	12.1	13.9	18.0	27.0
		5	21.6	24.3	27.7	36.0	54.0
		3	36.0	40.5	46.2	60.1	90.1
		1	108.1	121.5	138.6	180.2	270.2
		0.5	216.2	243.0	277.2	360.4	540.4
		0.2	540.6	607.4	693.1	900.9	1351.1
		0.1	1081.2	1214.8	1386.1	1801.8	2702.2
	1024 × 768	15	10.1	11.3	14.4	18.7	28.2
		10	15.1	16.9	21.6	28.1	42.4
		5	30.2	33.8	43.2	56.1	84.7
		3	50.4	56.3	72.1	93.6	141.2
		1	151.2	168.9	216.2	280.7	423.7
		0.5	302.4	337.8	432.4	561.5	847.5
		0.2	756.0	844.6	1081.0	1403.7	2118.6
		0.1	1512.1	1689.2	2162.0	2807.4	4237.3
	800 × 600	15	16.4	18.5	23.6	30.7	46.4
		10	24.6	27.7	35.4	46.0	69.7
		5	49.1	55.4	70.9	92.0	139.3
		3	81.9	92.4	118.1	153.3	232.2
		1	245.7	277.1	354.3	459.8	696.7
		0.5	491.3	554.3	708.6	919.5	1393.4
		0.2	1228.3	1385.7	1771.6	2298.8	3483.4
		0.1	2456.6	2771.4	3543.2	4597.5	6966.9
	640 × 480	30	12.9	14.4	18.5	24.0	36.0
		15	25.7	28.8	36.9	48.0	71.9
		10	38.6	43.2	55.4	72.0	107.9
		5	77.2	86.4	110.8	144.0	215.8
		3	128.6	144.1	184.6	240.0	359.7
		1	385.9	432.2	553.9	719.9	1079.0
0.5		771.9	864.4	1107.9	1439.7	2157.9	
0.2		1929.6	2161.0	2769.7	3599.4	5394.9	
320 × 240	0.1	3859.3	4321.9	5539.5	7198.7	10789.7	
	30	20.6	27.7	34.3	47.9	65.3	
	15	41.1	55.4	68.5	95.8	130.5	
	10	61.7	83.0	102.8	143.8	195.8	
	5	123.4	166.1	205.5	287.5	391.6	
	3	205.7	276.8	342.6	479.2	652.7	
	1	617.2	830.4	1027.7	1437.5	1958.0	
	0.5	1234.3	1660.9	2055.4	2875.0	3916.0	
	0.2	3085.9	4152.1	5138.5	7187.5	9790.1	
	0.1	6171.7	8304.3	10277.1	14375.1	19580.2	

- Recording time varies depending on the recording rate and recording image quality. The recording times indicated in the table are reference values when an external hard disk is installed on this camera that may vary depending on the video image quality and other conditions.
- La durée d'enregistrement varie en fonction du taux d'enregistrement et de la qualité de l'image enregistrée. Les durées d'enregistrement indiquées dans le tableau sont des valeurs de référence quand un disque dur externe est installé sur cette caméra ; elles peuvent varier en fonction de la qualité de l'image vidéo et d'autres conditions.
- Die Aufnahmezeit variiert je nach Aufnahmegeschwindigkeit und Qualität des aufgenommenen Bildes. Die in der Tabelle angeführten Aufnahmezeiten dienen als Referenzwerte, wenn für diese Kamera eine externe Festplatte installiert wurde, und können je nach Videobildqualität und anderen Bedingungen variieren.
- El tiempo de grabación varía en función de la tasa de grabación y de la calidad de las imágenes de grabación. Los tiempos de grabación que se indican en la anterior son valores de referencia cuando un disco duro externo está instalado en esta cámara los mismos que podrían variar en función de la calidad de imágenes y otras condiciones.
- 录像时间会根据录像速率和录像图像质量而变化。表中表示的录像时间为该摄像头安装外置硬盘之后的参考值，它们可能会根据视频图像质量及其它条件而变化。

VCC-HD4000

- ② SD memory card recording time
- ② Durée d'enregistrement de la carte mémoire SD
- ② SD-Speicherkarte Aufnahmezeit
- ② Tiempo de grabación de la tarjeta de memoria SD
- ② SD 记忆卡录像时间

2GB	Picture quality		SUPER FINE	FINE	ENHANCED	NORMAL	BASIC
	Resolution	Recording rate (ips)					
H.264 (16:9)	1920 × 1080p	30	0.3	0.4	0.4	0.5	0.6
		15	0.3	0.4	0.5	0.6	0.8
	1280 × 720p	25	0.4	0.4	0.5	0.7	1.0
		12.5	0.4	0.5	0.6	0.8	1.1
	960 × 540p	25	0.5	0.6	0.8	1.1	1.9
		12.5	0.6	0.8	1.0	1.4	2.3
	640 × 360p	25	1.4	1.7	2.1	2.9	4.5
		12.5	1.6	1.9	2.4	3.2	4.9
	320 × 180p	25	4.9	5.8	7.0	8.6	11.9
		12.5	5.4	6.4	7.6	9.6	13.1
H.264 (4:3)	1080 × 720p	25	0.4	0.4	0.5	0.7	1.0
		12.5	0.4	0.5	0.6	0.8	1.1
	720 × 480p	25	0.7	0.9	1.1	1.6	2.5
		12.5	0.8	1.0	1.2	1.7	2.8
	360 × 240p	25	2.5	3.0	3.8	5.1	8.1
		12.5	2.8	3.3	4.2	5.7	8.9
JPEG (16:9)	1920 × 1080	5	0.3	0.4	0.4	0.5	0.7
		2.5	0.5	0.6	0.7	0.9	1.2
		1	1.5	1.8	2.1	2.6	3.5
		0.5	3.0	3.5	4.2	5.2	7.0
		0.2	7.6	8.8	10.5	13.1	17.4
		0.1	15.2	17.6	21.0	26.2	34.9
	1280 × 720	8	0.3	0.4	0.4	0.5	0.8
		5	0.6	0.7	0.8	1.0	1.6
		2.5	1.0	1.2	1.3	1.7	2.6
		1	3.1	3.5	4.0	5.2	7.8
		0.5	6.3	7.0	8.1	10.5	15.7
		0.2	15.7	17.6	20.1	26.2	39.2
	1024 × 576	0.1	31.4	35.1	40.3	52.3	78.5
		12.5	0.4	0.4	0.5	0.7	1.0
		8	0.5	0.6	0.8	1.0	1.5
		5	1.1	1.2	1.5	2.0	3.0
		2.5	1.8	2.0	2.6	3.3	5.1
		1	5.4	6.0	7.7	10.0	15.2
	640 × 360	0.5	10.7	12.1	15.4	20.0	30.4
		0.2	26.8	30.2	38.6	50.1	75.9
		0.1	53.5	60.4	77.2	100.1	151.8
		25	0.3	0.3	0.4	0.5	0.8
		12.5	0.6	0.6	0.8	1.0	1.6
		8	0.8	0.9	1.2	1.6	2.4
	640 × 360	5	1.7	1.9	2.4	3.1	4.7
		2.5	2.8	3.1	4.0	5.2	7.8
		1	8.4	9.4	12.1	15.7	23.5
		0.5	16.8	18.8	24.1	31.4	47.0
		0.2	42.0	47.1	60.3	78.4	117.5
		0.1	84.1	94.1	120.7	156.8	235.0

- This table shows the total values for the normal area and the alarm area.
- Ce tableau indique les valeurs totales pour la zone normale et la zone d'alarme.
- In dieser Tabelle werden die Gesamtwerte des normalen Aufnahmebereichs und der Alarmaufnahmebereichs aufgeführt.
- Este cuadro muestra los valores totales para el área normal y el área de alarma.
- 本表显示正常区域和警报区域的总值。

2GB	Picture quality		SUPER FINE	FINE	ENHANCED	NORMAL	BASIC
	Resolution	Recording rate (ips)					
JPEG (4:3)	2288 × 1712	3	0.3	0.3	0.4	0.6	0.8
		1	0.9	1.0	1.3	1.7	2.4
		0.5	1.7	2.1	2.5	3.3	4.7
		0.2	4.4	5.2	6.4	8.3	11.8
		0.1	8.7	10.4	12.7	16.5	23.6
	1600 × 1200	5	0.3	0.4	0.5	0.6	0.9
		3	0.6	0.7	0.8	1.0	1.4
		1	1.7	2.0	2.5	3.1	4.3
		0.5	3.5	4.1	5.0	6.3	8.6
		0.2	8.7	10.2	12.4	15.7	21.4
		0.1	17.4	20.5	24.8	31.4	42.8
	1280 × 960	10	0.2	0.3	0.3	0.4	0.6
		5	0.5	0.5	0.6	0.8	1.2
		3	0.8	0.9	1.0	1.3	2.0
		1	2.4	2.6	3.0	3.9	5.9
		0.5	4.7	5.3	6.0	7.8	11.8
		0.2	11.8	13.2	15.1	19.6	29.4
		0.1	23.6	26.5	30.2	39.2	58.9
	1024 × 768	15	0.2	0.2	0.3	0.4	0.6
		10	0.3	0.4	0.5	0.6	0.9
		5	0.7	0.7	0.9	1.2	1.8
		3	1.1	1.2	1.6	2.0	3.1
		1	3.3	3.7	4.7	6.1	9.2
		0.5	6.6	7.4	9.4	12.2	18.5
		0.2	16.5	18.4	23.5	30.6	46.1
		0.1	32.9	36.8	47.1	61.1	92.3
	800 × 600	15	0.4	0.4	0.5	0.7	1.0
		10	0.5	0.6	0.8	1.0	1.5
		5	1.1	1.2	1.5	2.0	3.0
		3	1.8	2.0	2.6	3.3	5.1
		1	5.4	6.0	7.7	10.0	15.2
		0.5	10.7	12.1	15.4	20.0	30.4
		0.2	26.8	30.2	38.6	50.1	75.9
		0.1	53.5	60.4	77.2	100.1	151.8
	640 × 480	30	0.3	0.3	0.4	0.5	0.8
		15	0.6	0.6	0.8	1.0	1.6
		10	0.8	0.9	1.2	1.6	2.4
		5	1.7	1.9	2.4	3.1	4.7
		3	2.8	3.1	4.0	5.2	7.8
		1	8.4	9.4	12.1	15.7	23.5
		0.5	16.8	18.8	24.1	31.4	47.0
		0.2	42.0	47.1	60.3	78.4	117.5
		0.1	84.1	94.1	120.7	156.8	235.0
	320 × 240	30	0.4	0.6	0.7	1.0	1.4
		15	0.9	1.2	1.5	2.1	2.8
		10	1.3	1.8	2.2	3.1	4.3
		5	2.7	3.6	4.5	6.3	8.5
		3	4.5	6.0	7.5	10.4	14.2
1		13.4	18.1	22.4	31.3	42.6	
0.5		26.9	36.2	44.8	62.6	85.3	
0.2		67.2	90.4	111.9	156.6	213.2	
0.1		134.4	180.9	223.9	313.1	426.5	

- Recording time varies depending on the recording rate and recording image quality. The recording times indicated in the table are reference values when an SD memory card is installed in this camera that may vary depending on the video image quality and other conditions.
- La durée d'enregistrement varie en fonction du taux d'enregistrement et de la qualité de l'image enregistrée. Les durées d'enregistrement indiquées dans le tableau sont des valeurs de référence quand une carte mémoire SD est installée sur cette caméra ; elles peuvent varier en fonction de la qualité de l'image vidéo et d'autres conditions.
- Die Aufnahmezeit variiert je nach Aufnahmegeschwindigkeit und Qualität des aufgenommenen Bildes. Die in der Tabelle angeführten Aufnahmezeiten dienen als Referenzwerte, wenn für diese Kamera eine SD-Speicherkarte installiert wurde, und können je nach Videobildqualität und anderen Bedingungen variieren.
- El tiempo de grabación varía en función de la tasa de grabación y de la calidad de las imágenes de grabación. Los tiempos de grabación que se indican en la tabla son valores de referencia cuando una tarjeta de memoria SD está instalada en esta cámara los mismos que podrían variar en función de la calidad de imágenes y otras condiciones.
- 录像时间会根据录像速率和录像图像质量而变化。表中表示的录像时间为该摄像头安装 SD 记忆卡之后的参考值，它们可能会根据视频图像质量及其它条件而变化。

- Target size by resolution ■ Taille cible par résolution
- Zielgröße nach Auflösung ■ Tamaño del objetivo por resolución
- 根据分辨率设置的目标物体大小

VCC-HD4000P/VCC-HD4000/VCC-HDN4000PC

	Picture quality		SUPER FINE	FINE	ENHANCED	NORMAL	BASIC
	Resolution	Recording rate (ips)					
H.264 (16:9)	1920 × 1080p	25 (30)	8000	7000	6000	5000	4000
		12.5 (15)	7250	6250	5250	4250	3000
	1280 × 720p	25 (30)	6600	5600	4600	3600	2500
		12.5 (15)	5900	5000	4100	3200	2200
	960 × 540p	25 (30)	5000	4100	3200	2300	1300
		12.5 (15)	4000	3280	2550	1830	1100
	640 × 360p	25 (30)	1800	1480	1170	860	550
		12.5 (15)	1600	1330	1050	780	500
	320 × 180p	25 (30)	500	420	350	280	200
		12.5 (15)	450	380	320	250	180
H.264 (4:3)	1080 × 720p (1080 × 864p)	25 (30)	6600	5600	4600	3600	2500
		12.5 (15)	5900	5000	4100	3200	2200
	720 × 480p (720 × 576p)	25 (30)	3500	2870	2240	1600	980
		12.5 (15)	3200	2620	2050	1460	880
	360 × 240p (360 × 288p)	25 (30)	1000	830	650	480	300
		12.5 (15)	900	740	590	430	270
JPEG (16:9)	1920 × 1080	–	310	268	224	180	135
	1280 × 720	–	150	134	117	90	60
	1024 × 576	–	88	78	61	47	31
	640 × 360	–	56	50	39	30	20
JPEG (4:3)	2288 × 1712	–	540	455	370	285	200
	1600 × 1200	–	270	230	190	150	110
	1280 × 960	–	200	178	156	120	80
	1024 × 768	–	143	128	100	77	51
	800 × 600	–	88	78	61	47	31
	640 × 480	–	56	50	39	30	20
	320 × 240	–	35	26	21	15	11

- The target sizes are reference values that may vary depending on the video image quality and other conditions.
- Values in parenthesis are for NTSC.

- Les tailles cibles sont des valeurs référencées qui peuvent varier en fonction de la qualité d'image et d'autres conditions.
- Les valeurs entre parenthèses sont pour NTSC.

- Bei den Zielgrößen handelt es sich um Referenzwerte, die je nach Videobildqualität und anderen Bedingungen variieren können.
- Die Werte in Klammern gelten für NTSC.

- Los tamaños del objetivo y valores de referencia podrían variar en función de la calidad de las imágenes y otras condiciones.
- Los valores entre paréntesis son para NTSC.

- 目标物体大小为参考值，它们可能会根据视频图像质量及其它条件而变化。
- 括号中的值适用于 NTSC。

Display Information

● Error message

E01: HDD ERROR

E02: SD CARD ERROR

E03: TEMPERATURE ERROR

● Warning message

W01: FAN WARNING

W02: POWER RECOVER/POWER LOSS

W03: USB CURRENT WARNING

W04: NORMAL RECORDING AREA FULL

W05: ALARM RECORDING AREA FULL

W10: HDD TEMPERATURE

W11: NO MEDIA

● System information

S01: RESTORE FACTORY SETTINGS

S02: FIRMWARE UPDATE:MAIN

S03: FIRMWARE UPDATE:SUB

S04: HDD FORMAT

S05: SD CARD FORMAT

S06: RESTORE SETTINGS/COPY RECORDING AREA SETTINGS: ON

S07: RESTORE SETTINGS/COPY RECORDING AREA SETTINGS: OFF

Dimensions

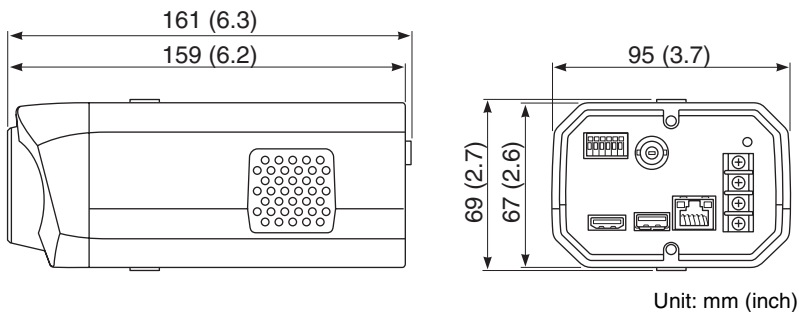

Accessories

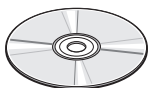

(VCC-HD4000)



*1 VCC-HD4000P : English/Français/Deutsch/中文简体
VCC-HD4000 : English/Français/Español
VCC-HDN4000PC : 中文简体